The Combined Effects of Residual Stress and Warm Prestressing on Cleavage Fracture in Steels

Derreck Van Gelderen (D.VanGelderens@bristol.ac.uk)

*Solid Mechanics Group
Department of Mechanical Engineering*

Outline

Introduction

The Problem

The Chell Model

Loading Regimes

Why Monte Carlo Simulations?

Weibull Distribution

Statistical Analysis

Monte Carlo Simulation

Introducing Residual Stress

Using a Monte Carlo Simulation

Conclusion

Future Work

Outline

Introduction

The Problem

The Chell Model

Loading Regimes

Why Monte Carlo Simulations?

Weibull Distribution

Statistical Analysis

Monte Carlo Simulation

Introducing Residual Stress

Using a Monte Carlo Simulation

Conclusion

Future Work

Introduction

- ✦ Cleavage Fracture is one of the most severe and catastrophic types of failure found in ferritic Steel structures.
- ✦ Warm Prestressing (WPS) is widely acknowledged as being able to enhance apparent material toughness especially in ferritic steels that exhibit lower shelf cleavage fracture.
- ✦ Statistical analyses were carried out on experimental data provided by the Nuclear Research Institute (NRI) Řež, Czech Republic.
- ✦ A Monte Carlo Simulation of a WPS model has been developed and applied to the NRI data and could be used to underpin the treatment of WPS in the R6 procedure.

Outline

Introduction

The Problem

The Chell Model

Loading Regimes

Why Monte Carlo Simulations?

Weibull Distribution

Statistical Analysis

Monte Carlo Simulation

Introducing Residual Stress

Using a Monte Carlo Simulation

Conclusion

Future Work

The Problem

- ✦ The fracture mechanism of a ferritic steel is temperature dependent, **ductile** failure at high temperatures, and **brittle** fracture at low temperatures.
- ✦ Neutron Embrittlement reduces the steel's Fracture Toughness, which effectively shifts the transition curve.
- ✦ Significant scatter in Fracture Toughness affects the continuity between K_{IC} and K_f .

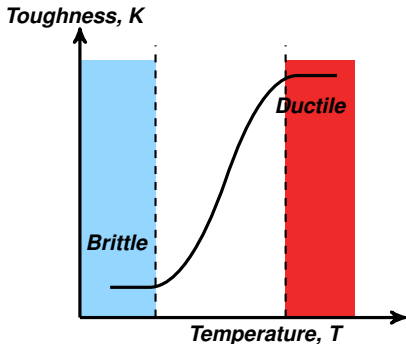

The Problem

- ✦ The fracture mechanism of a ferritic steel is temperature dependent, **ductile** failure at high temperatures, and **brittle** fracture at low temperatures.
- ✦ Neutron Embrittlement reduces the steel's Fracture Toughness, which effectively shifts the transition curve.
- ✦ Significant scatter in Fracture Toughness affects the continuity between K_{IC} and K_f .

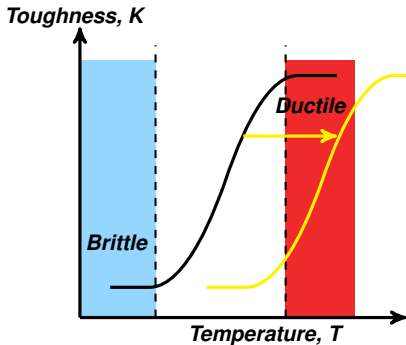

What is Warm Prestress?

- Warm Prestressing is widely acknowledged as being able to enhance a material's toughness; increasing resistance to brittle fracture.
- WPS effects are useful when considering accident scenarios, e.g. Loss-of-coolant-accidents (LOCA).

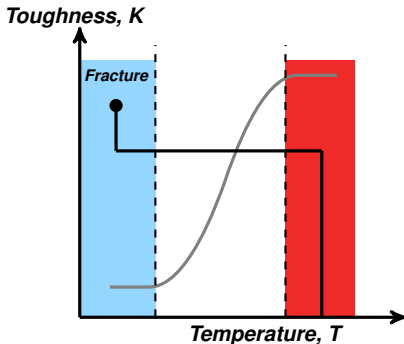

Outline

Introduction

The Problem

The Chell Model

Loading Regimes

Why Monte Carlo Simulations?

Weibull Distribution

Statistical Analysis

Monte Carlo Simulation

Introducing Residual Stress

Using a Monte Carlo Simulation

Conclusion

Future Work



Predicting WPS effect

- ✦ WPS - prior overload at a temperature higher than the transition and the subsequent operating temperature.
- ✦ Improvement in toughness caused majorly by:
 - Increasing in yield strength with decreasing temperature.
 - Formation of compressive residual stress field at crack tip.
- ✦ The Chell model relates the loading Γ applied to a contour integral enclosing the associated plastic strain at the crack tip.

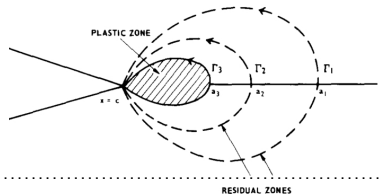

Outline

Introduction

The Problem

The Chell Model

Loading Regimes

Why Monte Carlo Simulations?

Weibull Distribution

Statistical Analysis

Monte Carlo Simulation

Introducing Residual Stress

Using a Monte Carlo Simulation

Conclusion

Future Work

Cool and Fracture (CF)

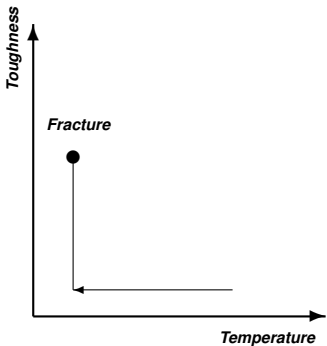

- ✦ CF loading regime used to determine original K_{Ic} .
- ✦ Corresponds to Case 3 of Chell's Model where the final loading step wipes out the effects of both Step 1 and 2.
- ✦ $S_2 < S_1 \leq S_3$

Load, Unload, Cool and Fracture (LUCF)

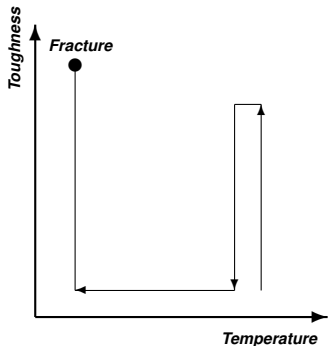

- ✦ LUCF loading regime involves unloading the preload prior to cooling.
- ✦ Corresponds to Case 1 of Chell's Model where the plastic zone induced from preloading is the largest.
- ✦ $S_3 \leq S_2 < S_1$

Load, Cool and Fracture (LCF)

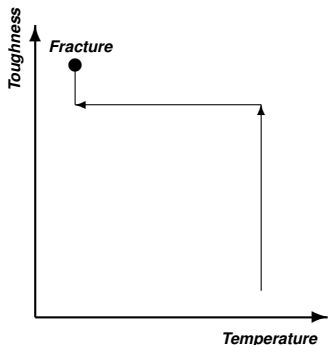

- ✦ LCF loading regime involves the cooling process to occur immediately after preloading.
- ✦ Corresponds to Case 2 of Chell's Model where the final loading step wipes out the plastic zone induced by the unloading step.
- ✦ $S_2 \leq S_3 \leq S_1$

Outline

Introduction

The Problem

The Chell Model

Loading Regimes

Why Monte Carlo Simulations?

Weibull Distribution

Statistical Analysis

Monte Carlo Simulation

Introducing Residual Stress

Using a Monte Carlo Simulation

Conclusion

Future Work

Generating 'Large Data'

- ✦ Two factors highlight why comparisons cannot be made between individual specimens:
 - Scatter found in the K_{Ic} data weakens assumption that specimens used for K_{Ic} and K_f are the same, even though assuming same geometry and material properties.
 - Lack of data implies that we don't know the 'correct' parameters associated with the distribution.
- ✦ Parameters that best fit the data are determined and used in the Monte Carlo Simulation.

Outline

Introduction

The Problem

The Chell Model

Loading Regimes

Why Monte Carlo Simulations?

Weibull Distribution

Statistical Analysis

Monte Carlo Simulation

Introducing Residual Stress

Using a Monte Carlo Simulation

Conclusion

Future Work



Obtaining Parameters...

The statistical tool which provides the best fit to the scatter found in fracture toughness is a 3 - Parameter Weibull distribution.

$$P_f = 1 - \exp \left(- \left(\frac{K - K_{min}}{K_o - K_{min}} \right)^{m_K} \right)$$

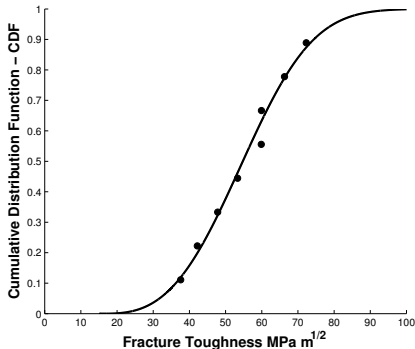

Figure: 3 Parameter Weibull Fit

Obtaining Parameters...

- ✦ m_K - Shape Parameter - dictates the shape of the distribution.
- ✦ K_o - Scale Parameter - acts as a characteristic value of the distribution.
- ✦ K_{min} - Threshold value - Corresponds to the value where the probability that a specimen will fracture is 0%.
- ✦ *Shape* and *Threshold* can be fixed and the results are compared with that obtained from using the best fit parameters.

Outline

Introduction

The Problem

The Chell Model

Loading Regimes

Why Monte Carlo Simulations?

Weibull Distribution

Statistical Analysis

Monte Carlo Simulation

Introducing Residual Stress

Using a Monte Carlo Simulation

Conclusion

Future Work

Methodology

- ✦ Experimental data was generated, at NRI for WWER 440 RPV steel, using single-edge-notched bend SE(B) specimens (pre-cracked charpy).
- ✦ Data was partitioned into sub-groups in order to determine which parameter had the greatest effect on enhancing toughness.
 - Fracture Temperature
 - Warm Prestress Temperature
 - Preload Level
- ✦ Results are tabulated displaying the percentage certainty of WPS having a positive effect.

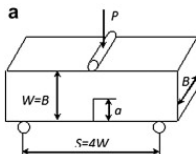



Statistical Analysis of Experimental Results

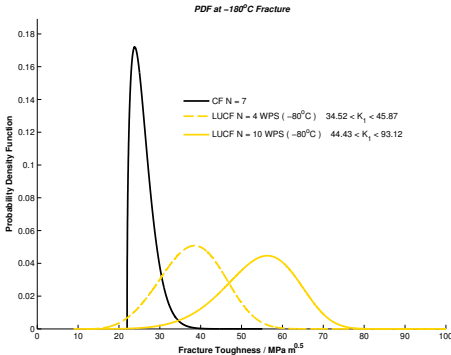

Figure: As-Received - LUCF - Comparing Preload Levels

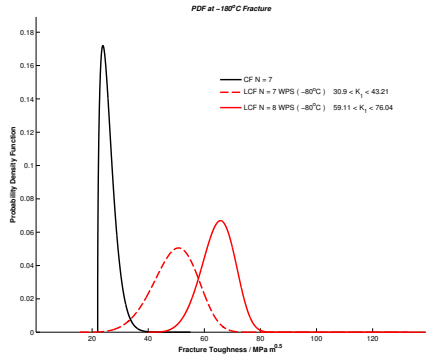

Figure: As-Received - LCF - Comparing Preload Levels

Outcomes

- ✦ The level of confidences obtained indicate clearly that Warm Prestress does indeed enhance the fracture toughness of this ferritic steel within statistical certainties.
- ✦ The confidence in demonstrating that there is a WPS effect was shown for -180°C - ranging from 91.6 - 99.6%.
- ✦ The Preload Level has a more significant effect than that of the WPS temperature.
- ✦ The Irradiated data exhibits the same pattern as the As-Received.

Outline

Introduction

The Problem

The Chell Model

Loading Regimes

Why Monte Carlo Simulations?

Weibull Distribution

Statistical Analysis

Monte Carlo Simulation

Introducing Residual Stress

Using a Monte Carlo Simulation

Conclusion

Future Work

Methodology

- ✦ WPS model developed by Chell is used to predict the change in toughness after WPS and evaluate its accuracy.
- ✦ Monte-Carlo methods are used to predict the distribution in toughness following different warm prestressing cycles.
- ✦ 3 Parameter Weibull distributions were used to map not only the scatter observed in the K_{IC} and K_f data, but also the variation found in the preload level, K_1 data.

Chell Prediction using MCS Results

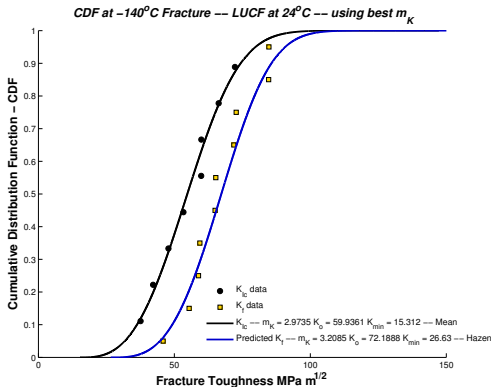

Figure: As-Received - CDF using best fit parameters with error bounds

Chell Prediction using MCS Results

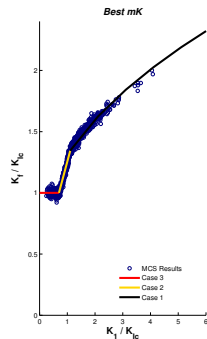
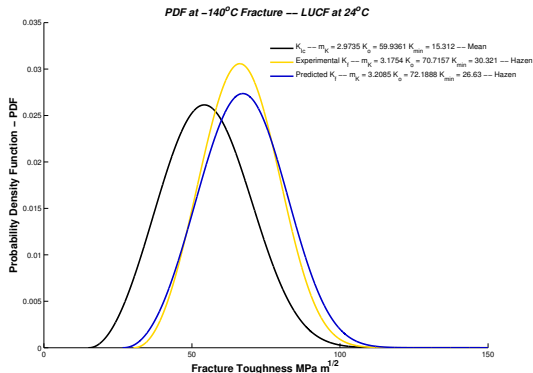

Figure: As-Received - PDF comparing both types of parameters

Figure: As-Received - display of the different cases occurring throughout the analysis

Outcomes

- ✦ The model predicts an increase in mean toughness increase to be within +/- 9% of the experimental value.
- ✦ The model provides a lower standard deviation compared with the experimental values.
- ✦ The best prediction was obtained from the group: Fracture Temp. – 140°C *WPS* 24°C - higher degree of plasticity at 24°C .

Outline

Introduction

The Problem

The Chell Model

Loading Regimes

Why Monte Carlo Simulations?

Weibull Distribution

Statistical Analysis

Monte Carlo Simulation

Introducing Residual Stress

Using a Monte Carlo Simulation

Conclusion

Future Work

Combining Residual Stress (RS) & Warm Prestress (WPS)

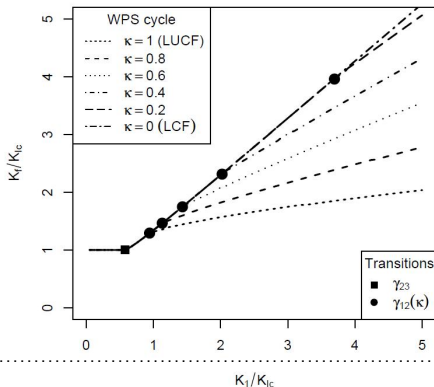

- ✦ Different levels of unloading can be used to represent different levels of initial RS.
- ✦ Obvious conclusion is that Tensile RS provides a benefit to WPS



Does the WPS relax the initial RS field?

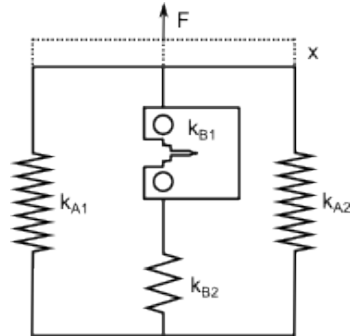
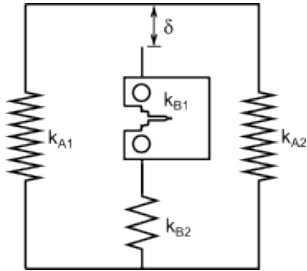

Does the WPS relax the initial RS field?

- ✦ Rate of RS relaxation depends on relative stiffness of cracked material to surrounding structure

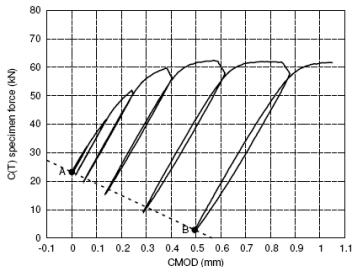

At room temperature during
preloading

Outline

Introduction

The Problem

The Chell Model

Loading Regimes

Why Monte Carlo Simulations?

Weibull Distribution

Statistical Analysis

Monte Carlo Simulation

Introducing Residual Stress

Using a Monte Carlo Simulation

Conclusion

Future Work

Monte Carlo Simulation of Structure

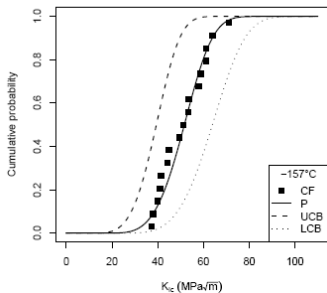

Figure: Statistical Variation of Toughness

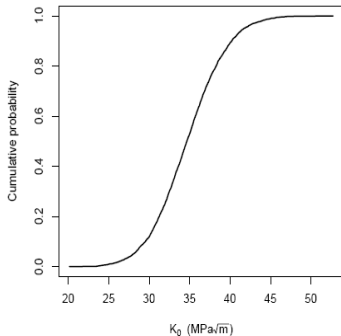
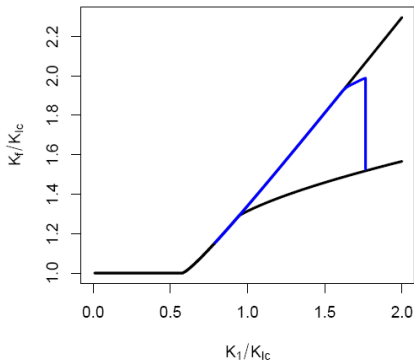
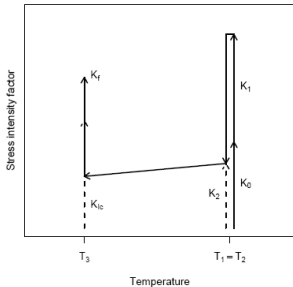

Figure: Statistical Variation of RS



Monte Carlo Simulation of Structure



Monte Carlo Simulation of Combined RS & WPS

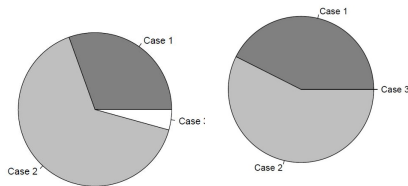
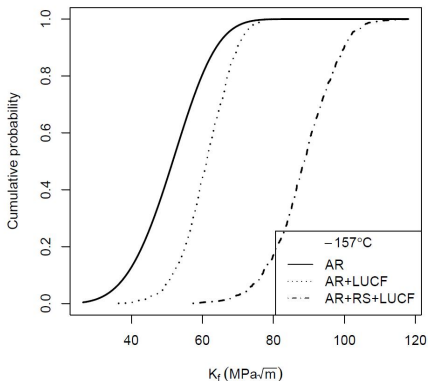

Figure: Without RS

Figure: With RS

Outline

Introduction

The Problem

The Chell Model

Loading Regimes

Why Monte Carlo Simulations?

Weibull Distribution

Statistical Analysis

Monte Carlo Simulation

Introducing Residual Stress

Using a Monte Carlo Simulation

Conclusion

Future Work

Conclusion

- ✦ Test data from pre-cracked charpy specimens clearly demonstrated the effects of WPS.
- ✦ A robust method for the statistical treatment of toughness data was established.
- ✦ The Chell model provided a good level of accuracy when predicting the mean toughness increase, but did not provide the same accuracy for the spread of the distribution.
- ✦ Predictions show that presence of high tensile residual stress provide an additional benefit from WPS to improvement in toughness.

Outline

Introduction

The Problem

The Chell Model

Loading Regimes

Why Monte Carlo Simulations?

Weibull Distribution

Statistical Analysis

Monte Carlo Simulation

Introducing Residual Stress

Using a Monte Carlo Simulation

Conclusion

Future Work



Looking Ahead...

- ✦ Experimental Programme - Further testing WPS effect with the presence of Residual Stress/Thermal stress.
- ✦ Attributing a level of significance to each parameter or physical effect, which acts to improve the toughness steel through WPS, would help to increase the accuracy of the model.

Thank you for listening...

ANY QUESTIONS?