

## FRACTURE UNDER COMBINED PRIMARY AND SECONDARY STRESSES

Bob Ainsworth

EDF Energy, Barnwood, Gloucester GL4 3RS, UK; bob.ainsworth@edf-energy.com

**Summary.** This article addresses the influence of combined primary and secondary stresses on elastic-plastic fracture. Although detailed finite element methods can be used to quantify the effects through calculation of  $J$  and for many years codes have provided simplified procedures for treating combined loading, this remains a topic of active research in order to provide improved guidance. Here, some of the underlying concepts and recent developments are discussed.

### Background

In the elastic region, primary and secondary stresses are simply added in the calculation of the total stress intensity factor. The treatment of secondary stresses in elastic-plastic fracture is more complex. One approach adopted in fitness-for-service procedures such as R6 [1] and API 579 [2] uses elastic calculations for the stress intensity factors and applies a multiplying factor,  $V$ , to the secondary stress intensity factor. This is equivalent to an estimate of  $J$  for the combined loading given by

$$J = (K_1^p + VK_1^s)^2 f^{-2}(L_r) / E' \quad (1)$$

where  $K_1^p, K_1^s$  are the stress intensity factors for primary and secondary stresses, respectively,  $E' = E$ , Young's modulus, in plane stress and  $E' = E/(1-\nu^2)$  where  $\nu$  is Poisson's ratio in plane strain. The function  $f(L_r)$  is the failure assessment curve in R6 which depends on the limit load parameter  $L_r$ :

$$L_r = F / F_L(a, \sigma_y) \quad (2)$$

where  $F$  represents the magnitude of the primary load and  $F_L$  is the corresponding collapse load which depends on crack size,  $a$ , and is proportional to yield stress,  $\sigma_y$ .

For low primary loads,  $f(L_r)$  is close to unity and eqn (1) recovers simple elastic response if  $V=1$ . More generally,  $V$  quantifies the effects of plasticity on the crack driving force with values greater than unity corresponding to positive interaction between the primary and secondary stresses and values less than unity corresponding to plastic relaxation of the secondary stresses. Indeed, eqn (1) can be

regarded as very general as  $f(L_r)$  can be based on finite element analysis to ensure accuracy for primary loads alone and  $V$  can be based on detailed finite element solutions for  $J$  for the combined loading.

To avoid having to use complex finite element analysis in routine assessments, codes such as R6 and API579 provide simplified estimates of  $V$ , corresponding to simplified estimates of  $J$ . These estimates of  $J$  have been based on reference stress analysis [3] supported by finite element and experimental validation for some limited cases [4]. However, more recently extensive detailed analyses have demonstrated that the simplified approaches can be over-conservative, particularly for large secondary stresses where plastic relaxation of the high elastically calculated stresses occurs, or conversely, non-conservative for small cracks in a region of uniform secondary stress [5-8]. Similar non-conservatism can occur for cases with significant elastic follow-up where plastic strains are concentrated in the region of the structure containing a crack.

A paper at ECF18 [9] presents methods for assessing elastic-plastic fracture and also creep fracture. This short article discusses some of the key features in the context of elastic-plastic fracture, presents finite-element results for a range of cases and illustrates where future developments may be possible.

### PARTICULAR CASES

#### Secondary Stresses Acting Alone

For secondary stresses in the absence of primary loads, eqn (1) can be interpreted as defining an initial value  $V_0$  of  $V$  as

$$V_0 = K_J^s / K_1^s \quad (3)$$

where  $K_1^s$  is the plastically corrected value of  $K_1^s$  and it has been noted that  $f(L_r)=1$  for  $L_r=0$ .

Often, it has been found that  $V_0$  is close to unity and Figure 1 illustrates this for a thin-walled cylinder ( $R/t=10$ ) with a linear through-wall (radial) temperature gradient for part-circumferential (angular extent  $2\theta$ ), part-through-wall (depth  $a$ ) defects for a Ramberg-Osgood material with a power-law index  $n=5$  [8]. Here, the magnitude of the secondary stress is presented in terms of a normalised parameter  $\beta$  defined by:

$$\beta = K_1^s / (K_1^p / L_r) \quad (4)$$

A value of  $\beta=1$  corresponds to the stress intensity factor for the secondary stress being equal to the stress intensity factor for a primary load equal to the limit load (i.e.  $L_r=1$ ; with the limit load being for a simple axial force in Figure 1).

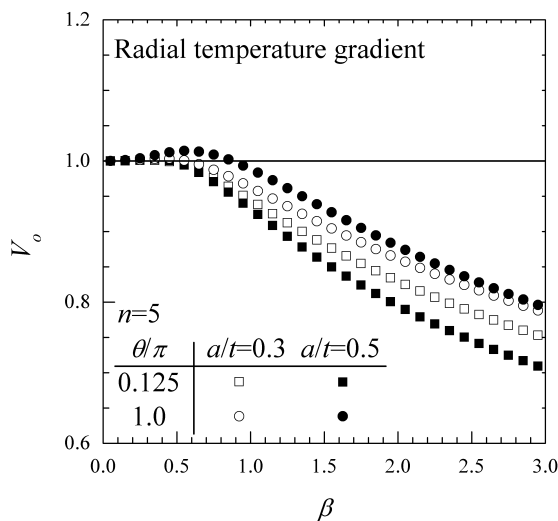

Figure 1 Solutions for through-wall thermal stresses acting alone.

Therefore,  $\beta$  can be interpreted as some average value of the secondary stress normalised by the yield stress and the value of  $\beta=3$  in Figure 1 corresponds to very high thermal stresses as a membrane stress equal to

$3\sigma_y$  would be required to generate the same stress intensity factor.

It can be seen from Figure 1 that the approximation  $V_0=1$  is accurate for a range of defect sizes for small  $\beta$  but that significant plastic relaxation occurs for secondary stresses in excess of the yield stress ( $\beta>1$ ). Thus, it could be overly conservative to neglect these effects and therefore codes need to provide methods for estimating  $K_J^s$  or the equivalent parameter  $V_0$ .

### Secondary Stresses with Elastic Follow-up

R6 notes that the simplified approaches that it presents for estimating  $V$  may not be appropriate for small cracks in a larger region of relatively uniform secondary stress. These cases may be associated with elastic follow-up and R6 suggests that such stresses may need to be treated as primary. This is illustrated for the case in Figure 2 where a temperature gradient has been imposed across the wall of a cylinder ( $R/t=10$ ) which elastically induces the thermal stress shown which has a region of uniform stress in the area of the defect. Corresponding results to those shown in Figure 1 for the through-wall temperature gradient are shown in Figure 3 [8].

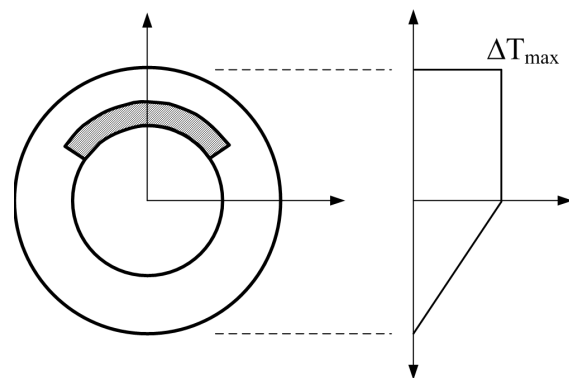

Figure 2 Sectional temperature gradient across a thin-walled cylinder

Compared to Figure 1, a stress exponent  $n=20$  has been used for the calculations in Figure 3. Although values of  $V_0$  for  $n=5$  tend to be higher than those shown in Figure 1 for the thermal stress field of Figure 2, the effects are much less pronounced than shown in Figure 3 [8].

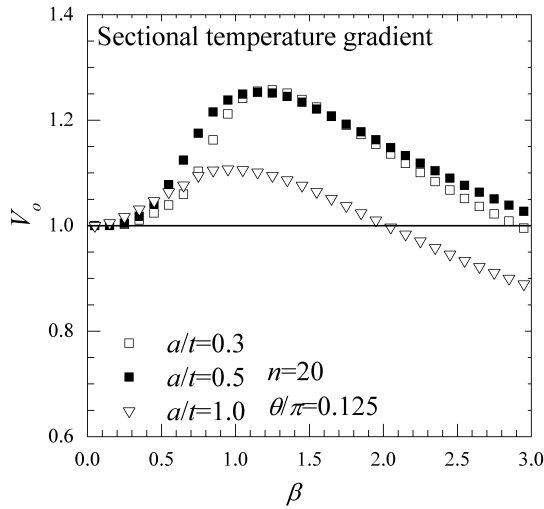

Figure 3 Solutions for sectional thermal stress acting alone

It is shown in [8], that the results for small  $\beta$  in Figure 3 can be reproduced if the secondary stresses are treated as primary. If elastic follow-up is interpreted as values of  $V_0$  significantly greater than unity (greater than 1.1, say), then extensive finite-element calculations [6-8] have shown that elastic follow-up tends to occur for: stress fields with a uniform region in the neighbourhood of the crack; low strain hardening materials (high  $n$ ); and small defects (note the lower values of  $V_0$  for the through-wall defect in Figure 3). Analyses have also shown that larger levels of plasticity due to high primary loads (high  $L_r$ ) or high secondary stresses (high  $\beta$ ) can reduce elastic follow-up effects.

### Combined Primary and Secondary Loading

Finite element analyses have also been performed for combined mechanical and thermal loading of a circumferentially cracked cylinder  $R/t=10$  [6-8]. The mechanical loading was applied as an axial force  $N$ . Elastic and elastic-plastic finite element analyses were performed for cases of primary load acting alone, secondary load acting alone and combined loading and converted to values of  $V_0$  and  $V$  by applying equation (1). This leads to  $V/V_0$  for the thermal loadings as functions of the level of axial stress and some results are shown in Figures 4 and 5. The normalising

load,  $N_{OR}$ , in these figures has been chosen to ensure that equation (1) is accurate for axial load acting alone so that the comparisons address the influence of combined loading on  $J$ . The figures include the simplified and detailed estimates of  $V/V_0$  given in R6 [1] and it can be seen that these are generally conservative.

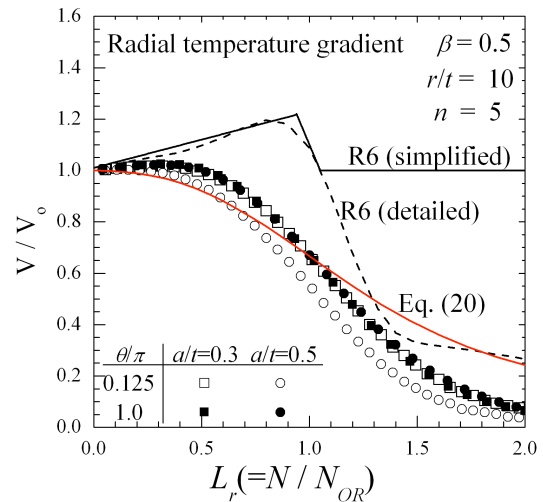

Figure 4 Elastic-plastic results after [8] for a small axial temperature gradient ( $\beta = K^s L_r / K^p = 0.5$ ).

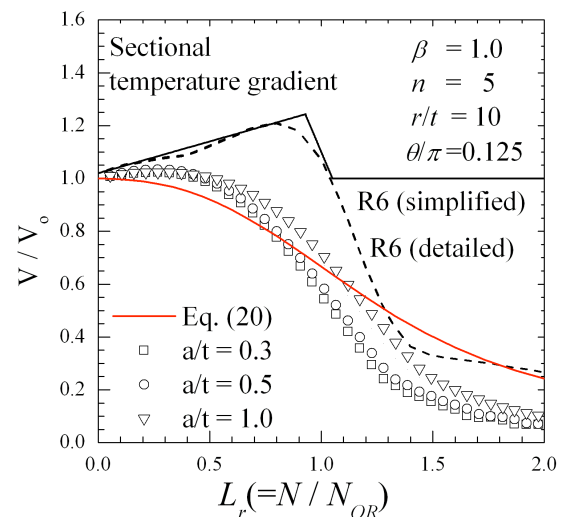

Figure 5 Elastic-plastic results after [6] for a modest sectional temperature gradient ( $\beta = K^s L_r / K^p = 1.0$ ).

An alternative less conservative estimate is shown as Eq. (20) in Figures 4 and 5 and this is the shape of the Option 2 failure assessment

curve in R6 [5, 6]. This enables accurate but not overly conservative estimates of  $V$ , and hence  $J$  for combined primary and secondary loading. More extensive results which show similar trends to those in Figures 4 and 5 are given in [5-9]. The important point is that when the results are presented in the form of these figures they are insensitive to crack size and the type of thermal loading, confirming that approximate estimation methods can be used.

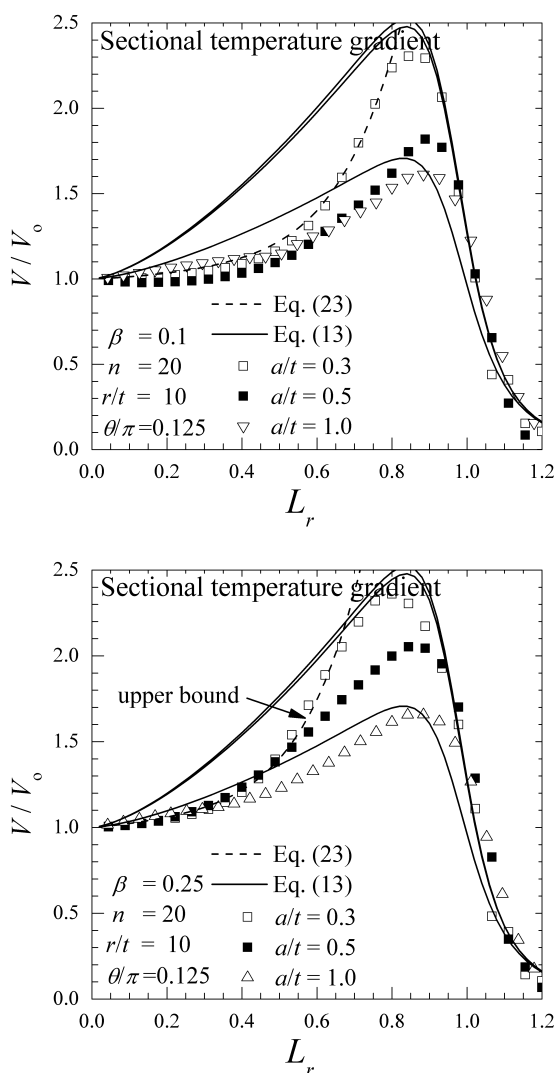

Figure 6 Elastic-plastic results for small sectional temperature gradients, demonstrating significant elastic follow-up, after [8].

As noted above, the sectional temperature gradient produces a region of uniform thermal stress in the region of the defects and may be associated with elastic follow-up. Extensive finite-element analyses recently reported in [8]

have found that this can occur and extreme examples are shown in Figure 6 for a flat stress-strain curve ( $n=20$ ). It can be seen that particularly for small defects, the finite element results lead to large values of  $V/V_0$ .

Also shown in the figures are two estimates: a dashed line denoted eqn (23) is an upper bound obtained by assuming the secondary stresses act as primary; and solid lines denoted eqn (13) are based on an estimate that describes plastic relaxation of the secondary stresses at large primary loads [8]. It can be seen that the results are close to the dashed line for contained yielding ( $L_r$  less than about 0.6). In [8], it is proposed that the lower of the upper bound (eqn 23) and the estimate based on plastic relaxation (eqn 13) is used. This leads to good estimates at low loads and also leads to accurate estimates at higher primary loads where elastic follow-up effects disappear as the secondary stresses are relaxed by widespread plasticity.

It is worth noting that the cases with large follow-up shown in Figure 6 correspond to uniform tensile stresses in the region of small defects so that there could be significant loss of constraint for these cases. Thus, it could be over-conservative to use the estimates of  $J$  with conventional fracture toughness values derived from deeply cracked bend specimens.

For cases without elastic follow-up, the plastic relaxation estimate (solid lines in Figure 6) falls below the upper bound and reduces to the estimate denoted eqn (20) in Figures 4, 5 so that the approach of using the lower of the two estimate (dashed and solid lines in Figure 6) provides a good fit to the data in these figures also.

## CLOSURE

This article has examined the treatment of combined primary and secondary stresses in elastic-plastic fracture. Although there are approaches for treating combined loading in existing procedures, these have limitations, particularly for secondary stresses with significant elastic-follow-up. In the elastic-plastic regime, it has been shown that secondary stresses with elastic follow-up can be treated as secondary provided appropriate

modifications are made to the parameter V which is used in failure assessment diagram methods. Detailed finite element analyses are being used to develop simplified estimates and these are likely to form the basis of extended advice in fitness-for-service procedures in the future.

## REFERENCES

- [1] *Assessment of the Integrity of Structures Containing Defects*, British Energy Generation Report R6 Revision 4, British Energy, Gloucester (2009).
- [2] *Fitness-For-Service*, API 579-1/ASME FFS-1-2007, Washington DC (2007).
- [3] Ainsworth, R A:  
The treatment of thermal and residual stresses in fracture assessments,  
*Engng Fract Mech* 24, (1986), pp. 65-76.
- [4] Ainsworth, R A ; Sharples, J K; Smith, S D: Effects of residual stresses on fracture behaviour – experimental results and assessment methods,  
*J Strain Analysis*, 35, (2000), pp. 307-316.
- [5] James, P. M; Hooton, D G; Madew, C J;Sharples, J K; Jackson, M:  
Extension of the simplified method for the interaction of primary and secondary stresses,  
*ASME Pressure Vessels and Piping Conference*, (2009), PVP2009-77367.
- [6] Song, T-K; Kim, Y-J; Nikbin, K; Ainsworth, R.A:  
Approximate J estimates for circumferential cracked pipes under primary and secondary stresses,  
*Engng Fract Mech*, 76 (2009), pp. 2109-2125.
- [7] Song, T-K; Kim, Y-J; Oh, C-K; Nikbin, K ; Ainsworth, R A:  
Estimation of V factor under combined thermal and mechanical stress for circumferential cracked pipes,  
*ASME Pressure Vessels and Piping Conference*, (2009), PVP2009-77355.
- [8] Song, T-K; Kim, Y-J; Ainsworth, R A; Nikbin, K N:  
Approximate J estimates for combined primary and secondary stresses with large elastic follow-up,  
*Engng Fract Mech* (2010), submitted for publication.
- [9] Ainsworth, R A:  
The treatment of combined primary and secondary stresses in elastic-plastic and creep fracture,  
*ECF18*, Dresden (2010).

## ESIS Procedures and Documents

(free available for ESIS Members at [www.structuralintegrity.eu](http://www.structuralintegrity.eu))

Two kinds of documents are produced by ESIS Technical Committees with the following designatory system: ESIS P2-92 or ESIS P4-92D, where:

1. P means "Procedure", and 2 and 4 are the current numbers, while 92 is the year of issue.
2. D following the year (eg: 92D) means "draft", ie: not yet approved, while
3. D prior to the year (eg: D1-92) means "Document" other than test methods.

<p><b>P1-92</b>  <b>ESIS RECOMMENDATIONS FOR DETERMINING THE FRACTURE RESISTANCE OF DUCTILE MATERIALS.</b>  Responsible body: TC1 Subcommittee on Fracture Mechanics Testing Standards.</p>
<p><b>P2-92</b>  <b>ESIS PROCEDURE FOR DETERMINING THE FRACTURE BEHAVIOUR OF MATERIALS.</b>  Responsible body: TC1 Subcommittee on Fracture Mechanics Testing Standards.</p>
<p><b>P3-03D</b>  <b>DRAFT UNIFIED PROCEDURE FOR DETERMINING THE FRACTURE BEHAVIOUR OF MATERIAL.</b>  Responsible body: TC1 Subcommittee on Fracture Mechanics Testing Standards (UNDER PREPARATION NOT AVAILABLE).</p>
<p><b>P4-92D</b>  <b>ESIS RECOMMENDATIONS FOR STRESS CORROSION TESTING USING PRE-CRACKED SPECIMENS.</b>  Responsible body: TC10 Committee on Environmental-Assisted Cracking.</p>
<p><b>P5-00/VAMAS</b>  <b>PROCEDURE FOR DETERMINING THE OF FRACTURE TOUGHNESS OF CERAMICS USING THE SEVNB METHOD .</b>  Responsible body: TC6 Committee on Ceramics.</p>
<p><b>P6-98</b>  <b>ESIS PROCEDURE TO MEASURE AND CALCULATE MATERIAL PARAMETERS FOR THE LOCAL APPROACH TO FRACTURE USING NOTCHED TENSILE SPECIMENS.</b>  Responsible body: TC8 Committee on Numerical Methods.</p>
<p><b>P7-00</b>  <b>ESIS PROCEDURE FOR DYNAMIC TENSILE TESTS</b>  Responsible body: TC5 Subcommittee on Dynamic Testing at Intermediate Strain rates.</p>
<p><b>P8-99D</b>  <b>ESIS DRAFT CODE OF PRACTICE FOR THE DETERMINATION AND INTERPRETATION OF CYCLIC STRESS-STRAIN DATA.</b>  Responsible body: TC11 Committee on High Temperature Mechanical Testing.</p>
<p><b>P9-02D</b>  <b>GUIDANCE ON LOCAL APPROACH OF RUPTURE OF METALLIC MATERIALS.</b>  (UNDER PREPARATION NOT AVAILABLE).</p>
<p><b>P10-02</b>  <b>A CODE OF PRACTICE FOR CONDUCTING NOTCHED BAR CREEP RUPTURE TESTS AND INTERPRETING THE DATA.</b>  Responsible body: TC11 High Temperature Mechanical Testing Committee.</p>
<p><b>P11-02</b>  <b>TECHNICAL RECOMMENDATIONS FOR THE EXTREME VALUE ANALYSIS OF DATA ON LARGE NONMETALLIC INCLUSIONS</b>  Responsible body: TC20 Committee on Inclusions.</p>
<p><b>D1-92</b>  <b>FRACTURE CONTROL GUIDELINES FOR STRESS CORROSION CRACKING OF HIGH STRENGTH ALLOYS.</b>  Responsible body: TC10 Committee on Environmental Assisted Cracking.</p>
<p><b>D2-99</b>  <b>FRACTURE TOUGHNESS OF CERAMICS USING THE SEVNB METHOD; ROUND ROBIN, TEST PROGRAMME.</b>  The ESIS TC6 and VAMAS TWA3 developed a test method and conducted a round robin for its validation. D2-99 presents a detailed documentation of this activity. The final form of the test method has appeared as P5-00.  Responsible body: TC6 Committee on Ceramics.</p>

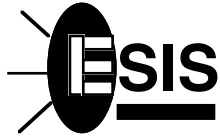

# 2010

## Membership Application Form

European Structural Integrity Society

1ST JANUARY 2010 to 31ST DECEMBER 2010

All members will be registered as Individual Members and will receive the ESIS Newsletter, once a year.

Membership Fees should be paid either by Cheque or by Credit Card to the value of € 30 (Euros).

*Please put a cross (X) in the appropriate box(es) :*

Register me as an ESIS member for the year 2010 and send the ESIS Newsletters to the address stated below (in BLOCK CAPITALS please).

Payment details. All cheques are to be made **payable to ESIS**.

Since the membership fee is exceedingly cheap, PLEASE REGARD THIS FORM AS AN OFFICIAL INVOICE, noting that on receipt of your payment you will receive an official receipt plus your ESIS 2010 membership number.

Enclosed is a cheque for € 30 (Euros) payable to ESIS (please write your name, and address on the reverse side of your cheque).

**OR**

Enclosed is a copy of bank transfer for € 30 (Euros) to ESIS account by the Unicredit Banca, Bank Code IT 22 N 02008 01160 000020016279.

**OR**

Please charge to my **(delete as appropriate)** EUROCARD / MASTER CARD / VISA CARD / DINERS CARD / AMERICAN EXPRESS CARD an amount of € 30 (Euros). My card number is:

<input type="text"/>	<input type="text"/>	<input type="text"/>	<input type="text"/>	<input type="text"/>	<input type="text"/>	<input type="text"/>	<input type="text"/>	Exp Date: <input type="text"/>	<input type="text"/>	-	<input type="text"/>	<input type="text"/>
----------------------	----------------------	----------------------	----------------------	----------------------	----------------------	----------------------	----------------------	-----------------------------------	----------------------	---	----------------------	----------------------

Surname: \_\_\_\_\_ Name \_\_\_\_\_ Title(s) \_\_\_\_\_

Affiliation: \_\_\_\_\_

Address: \_\_\_\_\_  
\_\_\_\_\_

e-mail: \_\_\_\_\_

Tel No: \_\_\_\_\_

Fax No: \_\_\_\_\_

Signature: \_\_\_\_\_

Date: \_\_\_\_\_

For ESIS records purposes please give the numbers of the ESIS Technical Committees in which you are most interested (see [www.structuralintegrity.eu](http://www.structuralintegrity.eu)).

Technical Committee(s):- \_\_\_\_\_

All ESIS Procedures and books are free for ESIS Members at [www.structuralintegrity.eu](http://www.structuralintegrity.eu)

**Please return this form to:**

ESIS Secretary  
Professor Giuseppe Ferro,  
Dept. of Structural Engineering,  
Politecnico di Torino,  
Corso Duca degli Abruzzi 24  
10129 Torino, Italy

or complete the web membership form at [www.structuralintegrity.eu](http://www.structuralintegrity.eu)

Please print clearly